

One Systems U-Bracket Installation Guide

February 2015

One Systems, Inc. offers a variety of U-Brackets for use with its loudspeaker systems. U-Brackets provide an easy way to achieve a vertical or horizontal wall mounting, or a ceiling parallel mount for loudspeaker systems.

Special Note: All U-Brackets for standard One Systems products are made with 316-grade stainless steel and are listed below.

Caution should be exercised when connecting One Systems Marine grade products and Marine grade rigging to other metallic, non 316-grade stainless steel surfaces (dissimilar metals). The potential for galvanic corrosion is high in marine environments where the One Systems enclosures and rigging are specified or required. Compatible metals and appropriate anode to cathode area ratios must be maintained. A structural engineer with galvanic corrosion experience should be consulted prior to installation of marine grade products, or ANY One Systems products in marine environments.

The following ONE SYSTEMS models may be mounted using a U-Bracket:

- ✓ 103/HTH*
- ✓ 106/HTH*
- ✓ 108/HTC
- ✓ 108/HTH
- ✓ 208/HTC
- ✓ 112/HTH
- ✓ 212/HC
- ✓ 312/HC
- ✓ 118/HSB
- ✓ Cross Field Array-2/HTH (CFA-2/HTH)

* The 103HTH and 106HTH are supplied with a U-Bracket as standard equipment.

IMPORTANT NOTE: All products in direct weather installations can be subjected to high wind speeds. For wind speed exposure over 74 miles per hour (119.1 kilometers per hour, 64.3 knots) the loudspeaker enclosure, bracket, and safety chain must be inspected for signs of damage or fatigue!

WARNING: Please read and understand all portions of the “Rigging and Suspension of ONE SYSTEMS Products” article (www.ONESYSTEMS.COM) under the Documents tab.

WARNING: All local and national codes must be observed when suspending this product. Consult a professional rigging specialist and structural engineer experienced in suspension of these types of products. Consult a professional rigger familiar with the appropriate local and national codes.

WARNING: All mating surfaces (i.e. walls, ceiling, etc) must be capable of supporting the U-Bracket and loudspeaker weight, and associated safety factors as required by local and national codes.

WARNING: Do not substitute the specific U-Bracket. Do not use the specific U-Bracket on any enclosure except for the enclosure specified. Do not suspend the enclosure with any U-Bracket except for the specified U-Bracket.

WARNING: All associated rigging is the responsibility of others.

INSTALLATION INSTRUCTIONS

112/HTH and 212/HC (use 112/HTH-U/M bracket)

1. See the product view below.



2. Remove the two M10 plastic covers from the positions as shown where the U-Bracket attaches to the enclosure. The mounting point shown in red is the ONLY U-Bracket attach point with one point on the bottom of the enclosure and one on the top.

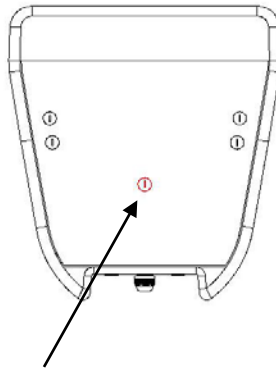

3. Mount the 112/HTH-U/M U-Bracket to the wall or ceiling surface. Insure that the bracket is properly and securely mounted. The mounting surface **MUST** be capable of supporting the necessary weight to achieve a safe working load. This must be done by a professional rigger or structural engineer familiar with all local and national codes.
4. Place the rubber washers (1 each) over each mounting hole between the enclosure and the U-Bracket.

WARNING: Do not hang or otherwise suspend any other objects from the loudspeaker and U-Bracket assembly!

- Position the enclosure between the U-Bracket ends. Install the two M10 bolts, flat washer and lock washers, one set on each side. This operation should be performed by at least two people. Once the enclosure is safely mounted, adjust to the desired angle and tighten the M10 bolts.

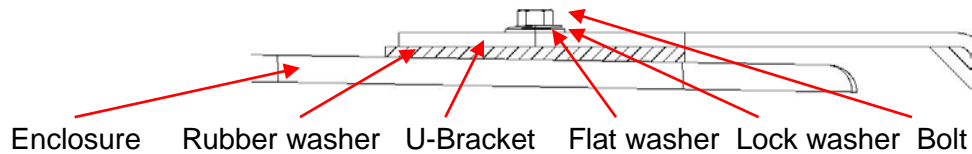

- A secondary safety cable (not supplied) is always recommended.

312/HC (use 312/HC-U/M bracket)

- See product view below (Figure 1)



- Remove the two M10 plastic covers from the positions as shown where the U-Bracket attaches to the enclosure. The mounting point shown in red is the ONLY U-Bracket attach point with one point on the top of the enclosure and one on the bottom.

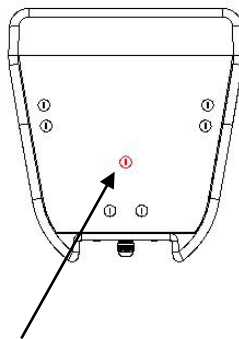

- Mount the U-Bracket to the wall or ceiling surface. Insure that the bracket is properly and securely mounted. The mounting surface **MUST** be capable of supporting the necessary weight to achieve a safe working load. This must be done by a professional rigger or structural engineer familiar with all local and national codes.
- Place the rubber washers (1 each) over each mounting hole, as shown where the U-Bracket and the enclosure meet.

WARNING: Do not hang or otherwise suspend any other objects from the loudspeaker and U-Bracket assembly!

- Position the enclosure between the U-Bracket ends. Install the two M10 bolts, flat washers and lock washers, one each side as shown in Figure 3. This operation should be performed by at least two people. Once the enclosure is safely mounted, adjust to the desired angle and tighten the M10 bolts.

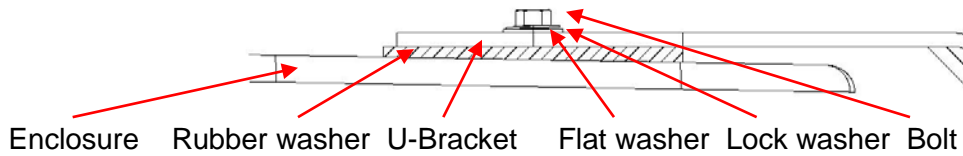

- A secondary safety cable (not supplied) is always recommended.

108/HTH/208/HTC (use 108/HTH-U/M bracket)

- Remove the two plastic plugs from the position shown below, one plug from the top of the enclosure and the second plug from the bottom of the enclosure.

NOTE: The U-Bracket MUST be mounted to the rigging points shown below. DO NOT USE THE OTHER M8 LOCATIONS FOR MOUNTING THE U-BRACKET!

- U-Bracket to the wall or ceiling surface. Insure that the bracket is properly and securely mounted. The mounting surface MUST be capable of supporting the necessary weight to achieve a safe working load. This must be done by a professional rigger or structural engineer familiar with all local and national codes.
- Place the rubber washers over the top and bottom “U” bracket mounting holes

WARNING: Do not hang or otherwise suspend any other objects from the loudspeaker and “U” bracket assembly!

- Position the 108/HTH or 208/HTC between the U-Bracket ends. Install the two M8 bolts, flat washers and lock washers, one set on each side. This operation should be performed by at least two people. Once the enclosure is safely mounted, adjust to the desired angle and tighten the M8 bolts.

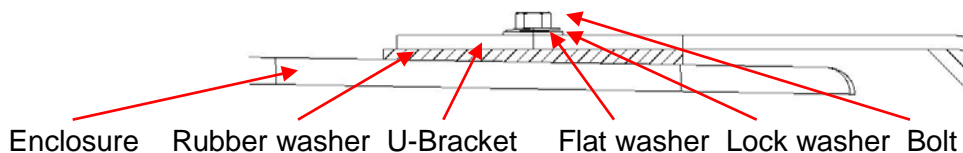

- A secondary safety cable (not supplied) is always recommended.

108/HTC (use 108/HTC-U/M bracket)

- Remove the two plastic plugs from the position shown below, one plug from the top of the enclosure and the second plug from the bottom of the enclosure.

NOTE: The U-Bracket MUST be mounted to the rigging points shown below. DO NOT USE THE OTHER M8 LOCATIONS FOR MOUNTING THE U-BRACKET!

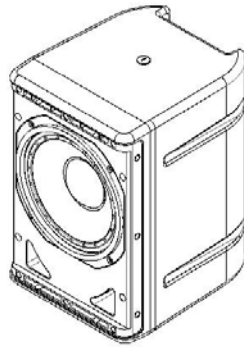

The image above shows the top of the 108/HTC. Use this location for the U-Bracket.

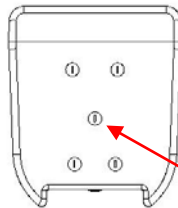

The image above shows the bottom of the 108/HTC. Use this location only for the U-Bracket!

2. Mount the 108/HTC-U/M U-Bracket to the wall or ceiling surface. Ensure that the bracket is properly and securely mounted. The mounting surface **MUST** be capable of supporting the necessary weight to achieve a safe working load. This must be done by a professional rigger or structural engineer familiar with all local and national codes.
3. Place the rubber washers over the top and bottom U-Bracket mounting holes

WARNING: Do not hang or otherwise suspend any other objects from the loudspeaker and U-Bracket assembly!

4. Position the 108/HTC between the U-Bracket ends. Install the two M8 bolts, flat washers and lock washers, one set on each side. This operation should be performed by at least two people. Once the enclosure is safely mounted, adjust to the desired angle and tighten the M8 bolts.

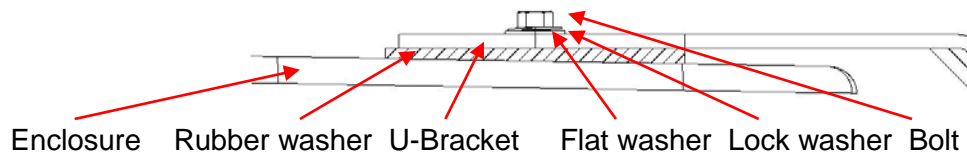

5. A secondary safety cable (not supplied) is always recommended.

103/HTH/106/HTH (brackets supplied with enclosure)

1. Remove the U-Bracket from the enclosure.
2. Mount the 103 or 106 U-Bracket to the wall or ceiling surface. Insure that the bracket is properly and securely mounted. The mounting surface **MUST** be capable of supporting the necessary weight to achieve a safe working load. This must be done by a professional rigger or structural engineer that is familiar with all local and national codes.
3. Place the rubber washers over the top and bottom of the enclosure if they have fallen off.
4. Position the 103/HTH or 106/HTH between the U-Bracket ends. Install the two bolts, flat washers and lock washers, one set on each side. Once the enclosure is safely mounted, adjust to the desired angle and tighten the bolts.

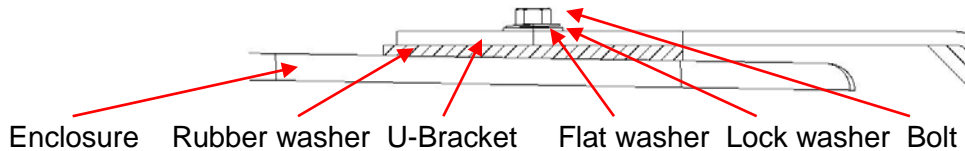

5. A secondary safety cable (not supplied) is always recommended.

WARNING: Do not hang or otherwise suspend any other objects from the loudspeaker and U-Bracket assembly!

Cross Field Array HTH – 2 (aka CFA-2 HTH), use CFA-2-U/M bracket

(See CFA-2/HTH manual)

<http://www.onesystems.com/pdf/education/CFA-2-Owners-Manual.pdf>

WARNING: Do not hang or otherwise suspend any other objects from the loudspeaker and U-Bracket assembly!

A secondary safety cable (not supplied) is always recommended.

118/HSB (use 118/HSB-U/M bracket)

For installations where mounting the 118/HSB with the optional U-Bracket (118/HSB-U/M), please refer to the 112/HTH installation instructions on page two of this manual. However, in the case of the 118/HSB, the mounting points are on top and the bottom of the enclosure as shown below. Use these mounting points **ONLY** for the 118/HSB with 118/HSB-U/M U-Bracket!

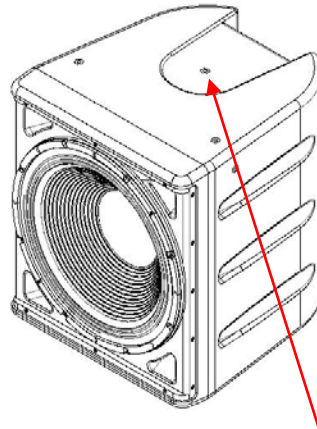

Use this point top and bottom **ONLY** for U-Bracket mount

WARNING: Do not hang or otherwise suspend any other objects from the loudspeaker and U-Bracket assembly!

A secondary safety cable (not supplied) is always recommended.

The products referenced in this manual are in conformity with the following standards or other normative documents: Machinery Directive 2006/42/EC

One Systems, Inc. * 2000 Glen Echo Rd. Ste. 210 * Nashville, TN 37215 *U.S.A.